

Pau &
LATORRE

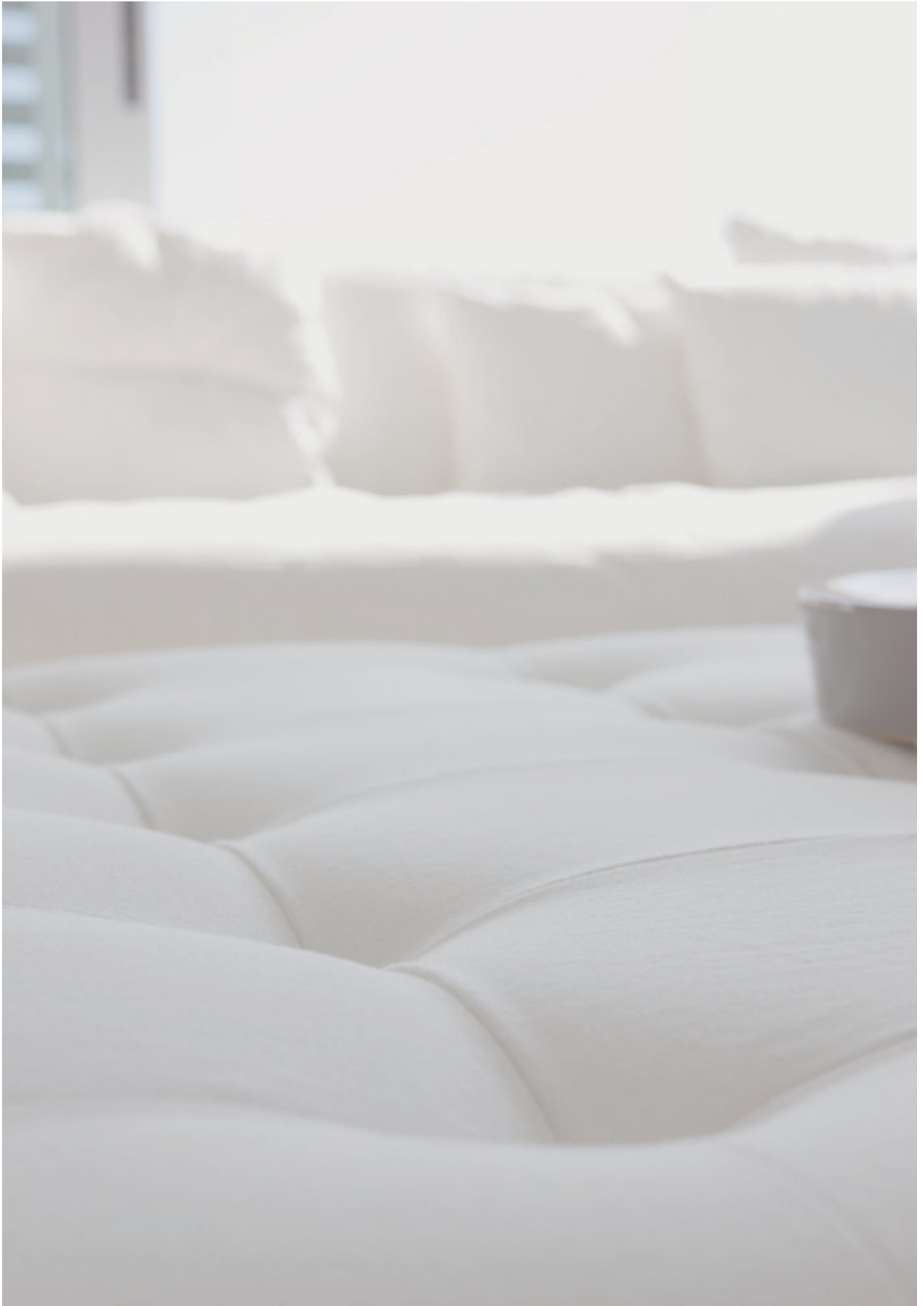



EN EL AÑO 2002 NACE LA NUEVA MARCA PAU& LATORRE PARA CREAR MUEBLE TAPIZADO DE DISEÑO. ES UN MOMENTO DE CAMBIOS DONDE LOS HIJOS DE LOS FUNDADORES DE LA EMPRESA, LIDERADOS POR ASCENSIÓN, FABRICAN UN PRODUCTO DE PRIMERA CLASE CON UNA EXIGENCIA EN EL ACABADO Y EN EL PROCESO DE FABRICACIÓN QUE HACE QUE, TANTO ASCENSIÓN LATORRE COMO PAU&LATORRE, VAYAN CONQUISTANDO NUEVOS MERCADOS Y CONSOLIDÁNDOSE A NIVEL INTERNACIONAL Y EUROPEO.

PAU&LATORRE ES UNA IDEA, UN CONCEPTO DE SOFÁ DE ALTO STANDING DENTRO DE LA ÚLTIMA TENDENCIA PERO PERDURABLE EN EL TIEMPO. PORQUE A PESAR DE SER UN PRODUCTO DE DISEÑO ES UNA CONCEPCIÓN CLÁSICA, PRECISAMENTE POR SU LONGEVIDAD. PAU&LATORRE ABARCA DESDE LÍNEAS DE ESTILO MÁS CASUAL E INFORMAL A LAS LÍNEAS MÁS AUSTERAS DEL DISEÑO CONTEMPORÁNEO.

ES UN COMPENDIO ENTRE EL GUSTO POR LA PERFECCIÓN, LA EXIGENCIA CONSTANTE EN LA TERMINACIÓN Y EL ACABADO MÁS SENCILLO. SIN NINGUNA CONCESIÓN A LO SOBRECARGADO.

NUESTRAS PIEZAS PRODUCEN SATISFACCIÓN Y CONFORT, CREANDO EN LOS HOGARES UN AMBIENTE DE LUJOSA SENCILLEZ. PARTE IMPORTANTE DE NUESTRA VIDA COTIDIANA DONDE EN DÍAS DE TRABAJO Y STRESS CADA VEZ ES MÁS IMPORTANTE SENTIRNOS RECONFORTADOS Y RELAJADOS AL LLEGAR A NUESTROS HOGARES, SIN ESTRIDENCIAS Y CON SENSACIÓN DE ESPACIO. EN RESUMEN, INTENTAMOS HACER QUE TODO RESULTE FÁCIL, NO SOLO LA DECORACIÓN, SINO TAMBIÉN NUESTRAS VIDAS...

IN 2002, THE NEW PAU&LATORRE BRAND WAS BORN WITH A WHOLE NEW STYLE AND RANGE OF FURNITURE. THE FIRM HEADED BY ASCENSIÓN AND NOW LED BY THE FOUNDER'S CHILDREN MANUFACTURES TOP QUALITY, HAND-MADE AND EXQUISITELY FINISHED FURNITURE. THIS NEW CONCEPT WON OVER NEW MARKETS AND CONSOLIDATED BOTH ASCENSIÓN LATORRE AND PAU&LATORRE IN EUROPE AND OTHER FOREIGN COUNTRIES.

PAU&LATORRE IS AN IDEA, AN AVANT-GARDE CONCEPT. LUXURY SOFAS ARE MADE AND DESIGNED TO WITHSTAND TIME. NEW LINES WITH A CLASSICAL CONCEPT. IT HAS BEEN CREATED TO LAST FOREVER. THE PAU&LATORRE RANGE COMBINES CASUAL, INFORMAL PIECES AS WELL AS SOBER AND CONTEMPORARY DESIGNS. THE PAU&LATORRE RANGE IS THE BLEND OF BEING METICULOUSLY PERFECT AND PROVIDING EXQUISITELY FINISHED PIECES WITH A YET SIMPLER AND MORE ELEGANT STYLE.

PAU&LATORRE MEANS COMFORT AND PLEASURE. RELAXING AND RESTING IN A SPACIOUS, PEACEFUL AND HARMONIOUS ATMOSPHERE IS BECOMING INVALUABLE.

PAU&LATORRE CREATES THIS FEELING OF LUXURY AND SIMPLICITY THAT IS THE PERFECT WAY TO GET BACK IN TOUCH WITH THE INNER SELF AFTER A HARD DAY. IN SHORT, PAU&LATORRE'S PHILOSOPHY AIMS TO MAKE YOUR LIFE MORE PLEASANT.

MADE
SPAIN

PAU COLLECTION

PRODUCT

TECHNICAL INFORMATION



PRODUCT

HARRY

SOFA

by GUILLERMO T

pau collection



HARRY



HARRY



HARRY



HARRY

PIERCE

SOFA

by GUILLERMO T

pau collection



PIERCE



PIERCE



PIERCE



PIERCE

URBAN

SOFA

by GUILLERMOT

pau collection



URBAN



URBAN



URBAN



URBAN

STEETSON

SOFA

by GUILLERMO T

pau collection



STEETSON



STEETSON



STEETSON



STEETSON



STEETSON

GUNILLA

SOFA

by GUILLERMO T

pau collection



GUNILLA



GUNILLA

GUNILLA



GUNILLA





GUNILLA

GUNILLA



MALMÖ

SOFA

by GUILLERMO T

pau collection



MALMÖ

MALMÖ





MALMÖ

COLUMBUS

SOFA

by GUILLERMO T

pau collection



COLUMBUS



COLUMBUS



COLUMBUS



COLUMBUS

SAM

SOFA

by GUILLERMO T

pau collection



SAM



SAM



SAM



SAM

LAWRENCE

SOFA

by GUILLERMO T

pau collection
LAWRENCE





LAWRENCE



LAWRENCE



LAWRENCE

STRADA

SOFA

by GUILLERMO T



STRADA

pau collection



STRADA



STRADA



STRADA



STRADA

SHAHEEN

SOFA

by GUILLERMO T

pau collection



SHAHEEN



SHAHEEN

SHAHEEN





SHAHEEN

GLASGOW

SOFA

by LATORRE

Design Department

pau collection



GLASGOW

GLASGOW



GLASGOW





GLASGOW

EDISON

SOFA

by XIMO ROCA

pau collection



EDISON



GLASGOW

WESTMINSTER

SOFA

by GUILLERMO T

pau collection



WESTMINSTER

ANDY

SOFA

by GUILLERMO T

pau collection



ANDY



ANDY



ANDY



ANDY





ANDY



ANDY



ANDY

ARHUS

SOFA

by GUILLERMO T

pau collection



ARHUS



ARHUS



ARHUS

AURES

WINGCHAIR

by XIMO ROCA

pau collection



AURES

collection

AURES





AURES YOU

A close-up photograph of a white fabric, likely a shirt collar or cuff, showing a detailed view of the stitching and the texture of the material. A dark vertical bar is overlaid on the left side of the image, containing the text 'TECHNICAL INFORMATION'.

TECHNICAL INFORMATION

“HAY UN MOMENTO EN LA VIDA EN QUE HAY QUE TOMAR GRANDES DECISIONES. POR EJEMPLO, AHORA. UN SOFÁ ES MUCHO MÁS QUE UN MUEBLE, PERSONALIZARLO SIGNIFICA HACERLO PARTE DE TÍ Y DE TU ESTILO. MODIFICA TAMAÑO, ELIGE TEJIDO Y COLOR DE LACADO. EN NUESTRO DEPARTAMENTO DE DISEÑO ESTUDIAREMOS TU BOCETO Y HAREMOS UN PRESUPUESTO ADAPTADO A TUS NECESIDADES PARA QUE TUS SUEÑOS SE HAGAN REALIDAD.”

“THERE COMES A TIME IN YOUR LIFE WHEN YOU HAVE TO MAKE BIG DECISIONS, NOWADAYS, FOR INSTANCE. A SOFA IS MORE THAN JUST ANOTHER PIECE OF FURNITURE, CUSTOMISING YOUR SOFA IS ABOUT MAKING IT YOURS AND HAVING IT REFLECT YOUR TASTE. CHOOSE A FABRIC AND FINISH FROM OUR RANGE AND OUR DESIGN DEPARTMENT WILL GIVE YOU A QUOTE TO SUIT YOUR BUDGET AND MAKE YOUR DREAMS COME TRUE.”

PAU TECHNICAL INFORMATION

SOFAS

COLUMBUS

by Guillermo T

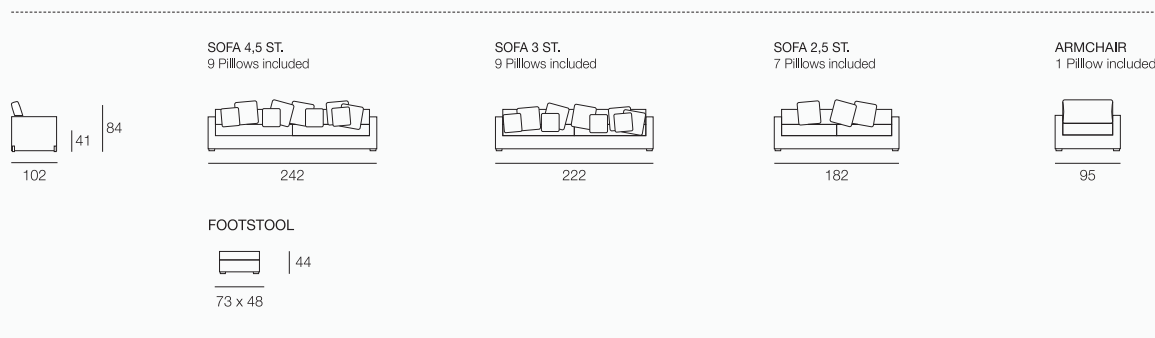

GLASGLOW

by LATORRE Design Department

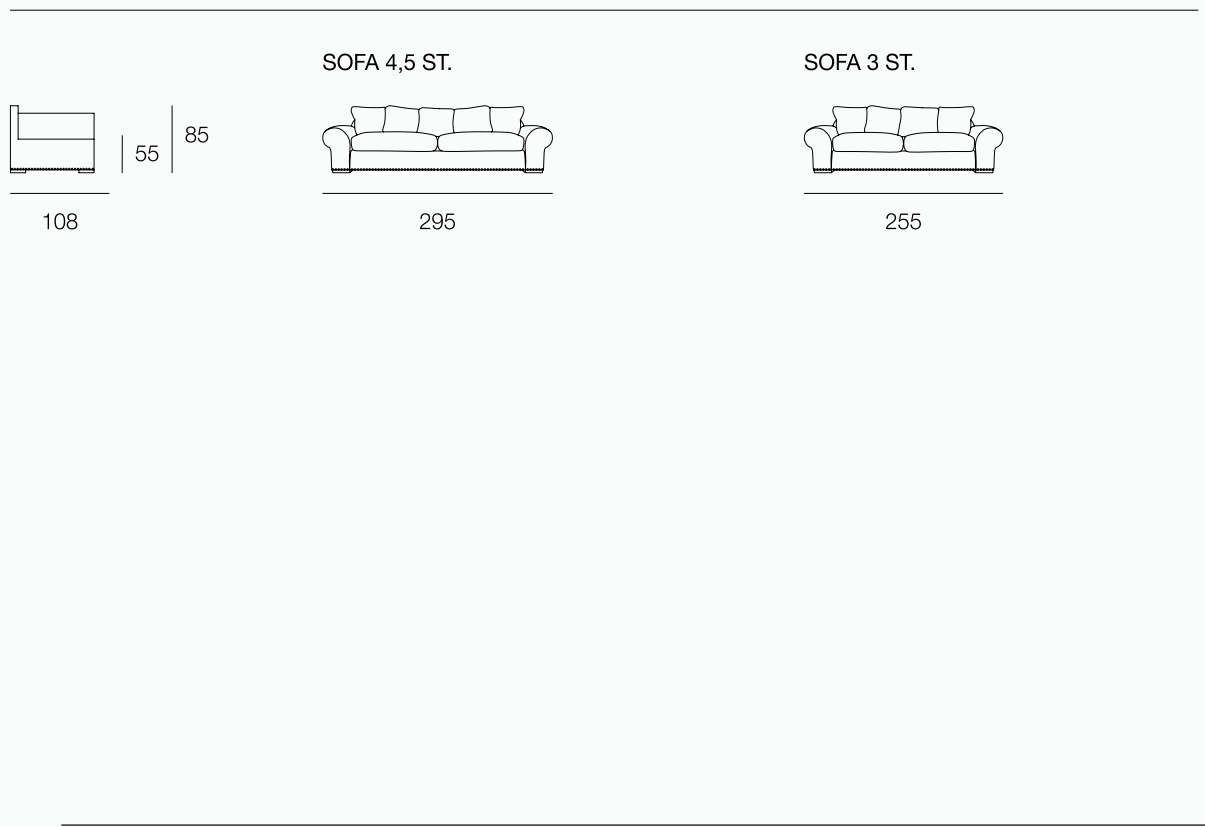

GUNILLA

by GuillermoT

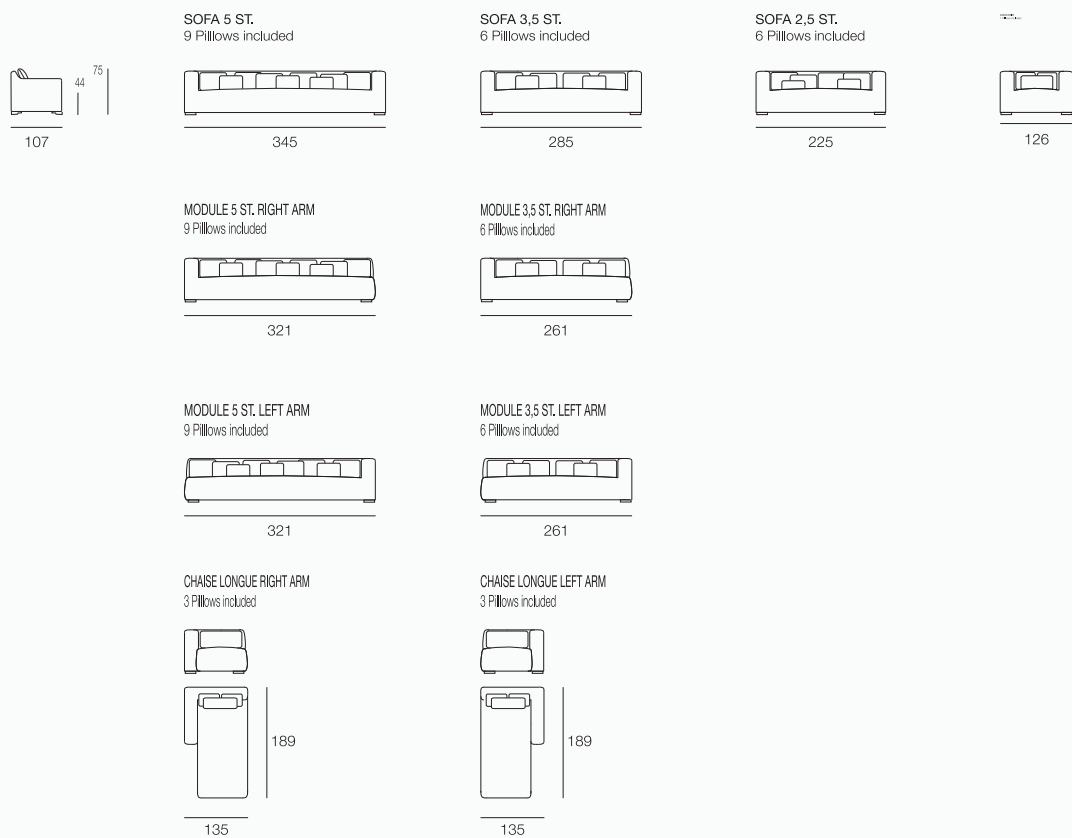

WESTMINSTE

design Guillermo T



SAM

by Guillermo T

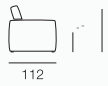

SOFA 5 ST.

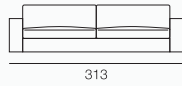

SOFA 3,5 ST.

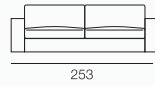

MODULE 5 ST. RIGHT ARM



MODULE 3,5 ST. RIGHT ARM

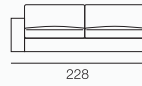

MODULE 5 ST. LEFT ARM

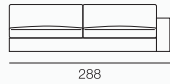

MODULE 3,5 ST. LEFT ARM

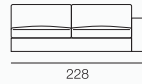

CHAISE LONGUE RIGHT ARM

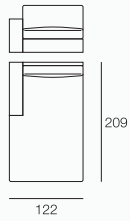

CHAISE LONGUE LEFT ARM

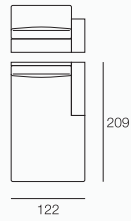

DOUBLE CHAISE LONGUE

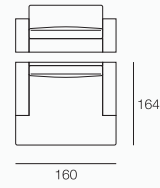

PAU TECHNICAL INFORMATION

SOFAS

SHAHEEN

by GuillermoT

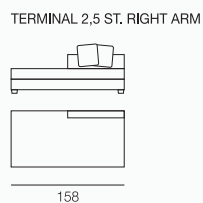
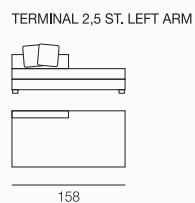
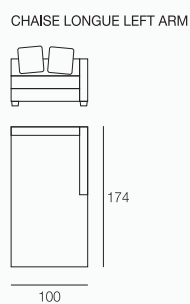
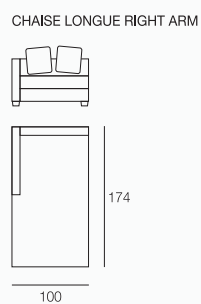
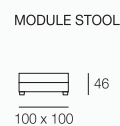
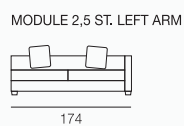
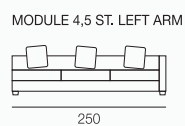
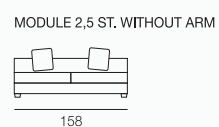
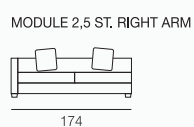
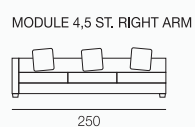
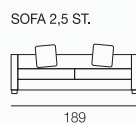
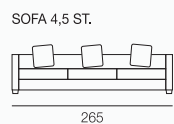
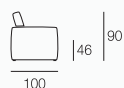

SHAHEEN SPECIAL With big back cushions - Con cojines de respaldo grandes
by Gullermt

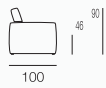

SOFA 4,5 ST.



SOFA 2,5 ST.

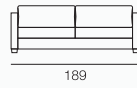

ARMCHAIR



FOOTSTOOL



MODULE 4,5 ST. RIGHT ARM

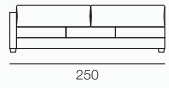

MODULE 2,5 ST. RIGHT ARM

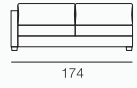

MODULE 2,5 ST. WITHOUT ARM

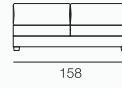

MODULE 4,5 ST. LEFT ARM

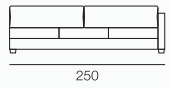

MODULE 2,5 ST. LEFT ARM



MODULE STOOL

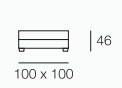

CHAISE LONGUE RIGHT ARM

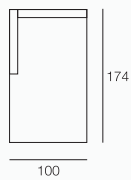

CHAISE LONGUE LEFT ARM

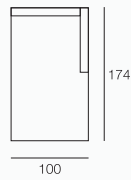

TERMINAL 2,5 ST. LEFT ARM

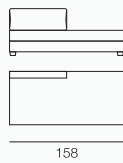

TERMINAL 2,5 ST. RIGHT ARM

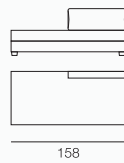

CORNER

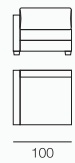

PAU TECHNICAL INFORMATION

SOFAS

LAWRENCE

by G. Amati

page 049

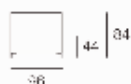

ARMCHAIR
2 Pillows included



95

LOVE SEAT 1,5 ST.
4 Pillows included



124

SOFA 4 ST.
7 Pillows included

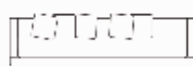

272

SOFA 3 ST.
6 Pillows included

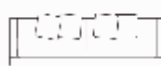

222

SOFA 2,5 ST.
5 Pillows included

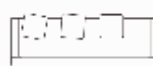

182

MODULE 4 ST. RIGHT ARM
6 Pillows included



261

MODULE 3 ST. RIGHT ARM
5 Pillows included



211

MODULE 2,5 ST. RIGHT ARM
5 Pillows included



171

MODULE 4 ST. LEFT ARM
6 Pillows included

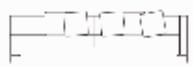

261

MODULE 3 ST. LEFT ARM
5 Pillows included

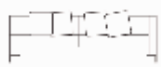

211

MODULE 2,5 ST. LEFT ARM
5 Pillows included



171

CHAISE LONGUE RIGHT ARM
6 Pillows included



95

131

CHAISE LONGUE LEFT ARM
6 Pillows included



95

131

PAU TECHNICAL INFORMATION

SOFAS

STRADA

by GuillemoT

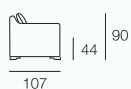

SOFA 6 ST.
4 Pillows included

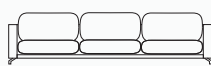

341

SOFA 5 ST.
4 Pillows included



294

SOFA 4 ST.
2 Pillows included



234

ARMCHAIR



116

MODULE 6 ST. LEFT ARM
4 Pillows included



332

MODULE 5 ST. LEFT ARM
4 Pillows included



285

MODULE 4 ST. LEFT ARM
2 Pillows included

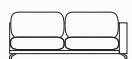

225

ARMCHAIR LEFT ARM



107

MODULE 6 ST. RIGHT ARM
4 Pillows included



332

MODULE 5 ST. RIGHT ARM
4 Pillows included



285

MODULE 4 ST. RIGHT ARM
2 Pillows included



225

ARMCHAIR RIGHT ARM



107

MODULE 6 ST. WITHOUT ARM
4 Pillows included



323

MODULE 5 ST. WITHOUT ARM
4 Pillows included



276

MODULE 4 ST. WITHOUT ARM
2 Pillows included



216

ARMCHAIR WITHOUT ARM



98

CHAISE LONGUE LEFT ARM
2 Pillows included

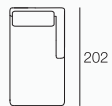

96

CHAISE LONGUE RIGHT ARM
2 Pillows included

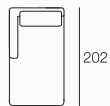

96

CHAISE LONGUE XL LEFT ARM
2 Pillows included

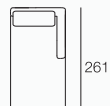

114

CHAISE LONGUE XL RIGHT ARM
2 Pillows included

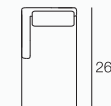

114

STOOL



107 x 107

CORNER



107

PAU TECHNICAL INFORMATION

SOFAS

Andy.
design GuillermoT

SOFA 1 ST.

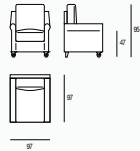

1.5 ST.

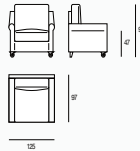

2 ST.

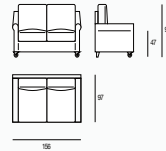

3 ST.

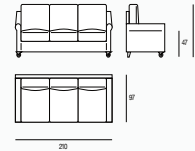

CHAISE LONGUE

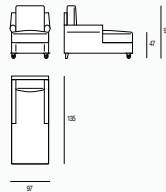

SOFA BED 1.5 ST. MATTRESS 80x190

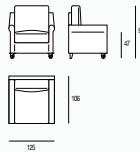

SOFA BED 2 ST. MATTRESS 135x190

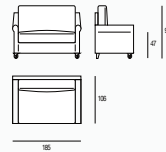

FOOTSTOOL





ARTESANIA



COMUNITAT
VALENCIANA



COLLABORATING FIRM:



CEU
*Universidad
Cardenal Herrera*

ASCENSIÓN LATORRE, S.L.

ALBACETE, 4
46113 MONTCADA, VALENCIA - SPAIN
TEL. +34 96 139 50 32
FAX +34 96 139 50 11
www.ascensionlatorre.com
www.paudesign.com

MAQUETACIÓN Y DISEÑO INMA ALBAJOS

PROYECTO GRÁFICO XIMO ROCA DISEÑO

DIRECCIÓN ARTE Guillermo T

FOTOGRAFÍA CLAUDIO INDIAS, MASFLASH, PEDRO LLORCA, CARLOS GUTIÉRREZ, DOLORS SERRA, NACHO PÉREZ, VÉRTICE FOTÓGRAFOS

IMPRIME KOLOR LITÓGRAFOS S.L.

COPYRIGHT © ASCENSIÓN LATORRE S.L. TODOS LOS DERECHOS RESERVADOS. ESTE CATÁLOGO SE HA PUBLICADO CON LA COLABORACIÓN DE LA CONSELLERIA D'INDÚSTRIA, COMERÇ I INNOVACIÓ DE LA GENERALITAT VALENCIANA.

